

Features

- 10:1 Ultra-Wide Input Range
- Operating Temperature Range: -40~105°C
- Approved to cURus, UKCA, CE, CB, RoHS, & REACH
- Safety Standards to IEC/UL/EN62368-1, EN45545-2 & EN50155
- Efficiency up to 93%
- EMC Class A & B
- Single output 16~160V DC
- Available with optional Heatsink



Ideal Power's 43HAE150-USxy 150W Series Half Brick DC/DC Converters are certified to cURus, UKCA, CE, CB, RoHS, REACH & IEC/UL/EN 62368-1, EN45545-2, EN50155 Standards and comply with the relevant Efficiency Regulations. These are primarily used in ITE, Video & Audio, Railway Industries and customised solutions are available upon request.

Part Number Structure

43HAE150-	72	S	05	U	A	-	P	TH
Series Name	Input Voltage (VDC)	Output Quantity	Output Voltage (VDC)	Input Range	Pin Connection Options		Remote On/Off Options	Assembly Options
	72: 16 ~ 160 (Continuous) 12 ~ 185 (Transient) *Compliant with 24 to 110V battery systems of EN50155	S: Single	3P3: 3.3 05: 5 12: 12 15: 15 24: 24 28: 28 48: 48	4:1	A: A type (Standard) B: B type		<input type="checkbox"/> : Negative logic <input type="checkbox"/> : Positive logic	<input type="checkbox"/> : None Heat-sink type HS1: 7GA0127P01-F; H=0.65" HS2: 7GA0128P01-F; H=1" Through hole type TH: No thread* *The module can't equip Heat-sink with TH option.

Models

Model Number	Input Range	Output Voltage	Output Current @Full Load mA	Input Current @No Load mA	Efficiency %	Maximum Capacitor Load μF
43HAE150-72S05UA/B	16 ~ 160	5	30	35	91	45000
43HAE150-72S12UA/B	16 ~ 160	12	12.5	20	93	8000
43HAE150-72S15UA/B	16 ~ 160	15	10	25	92	5000
43HAE150-72S24UA/B	16 ~ 160	24	6.3	20	89	2000
43HAE150-72S28UA/B	16 ~ 160	28	5.4	15	89	1470
43HAE150-72S48UA/B	16 ~ 160	48	3.2	20	93	470
43HAE150-72S53UA/B	16 ~ 160	53	2.9	30	91	390

Input Specifications

Parameter	Conditions	Min	Typ	Max	Unit
Operating input voltage range	72Vin(nom)	16	72	160	VDC
	Transient *Compliant with 24 to 110V battery systems of EN50155	12	--	185	
Start-up voltage	UVLO external resistor open	--	--	16	VDC
Shutdown voltage	UVLO external resistor open	10	11	12	VDC
Start-up time	Constant resistive load	Power up	--	350	ms
		Remote ON/OFF	--	350	
Input Transient voltage	100 mS, max.	12	--	--	VDC
Input surge voltage	1 second, max.	--	--	185	VDC
Input filter	C type				
Remote ON/OFF	Referred to -Vin pin	Negative logic	DC-DC ON	Short or 0 ~ 1.2VDC	
		(standard)	DC-DC OFF	Open or 3 ~ 12 VDC	
		Positive logic	DC-DC ON	Open or 3 ~ 12 VDC	
		(standard)	DC-DC OFF	Short or 0 ~ 1.2VDC	
		Input current of Ctrl pin	-0.5	1	mA
Remote off input current			15	mA	

Output Specifications

Parameter	Conditions	Min	Typ	Max	Unit
Voltage accuracy		-1.0	--	+1.0	%
Line regulation	Low Line to High Line at Full Load	-0.2	--	+0.2	%
Load regulation	No Load to Full Load	-0.1	--	+0.1	%
Voltage adjustability	Single output	-20	--	+10	%
Remote sense	% Of Vout(nom) If remote sense is not being used, Sense pins should be connected to corresponding polarity Vout pins.	--	--	10	%
Ripple and noise	Measured by 20MHz bandwidth With a 22µF/25V X7R MLCC and a 22µF/25V POS-CAP	5Vout	--	75	--
	With a 22µF/25V X7R MLCC and a 22µF/25V POS-CAP	12Vout, 15Vout	--	150	--
	With a 2.2µF/50V X7R MLCC	24Vout, 28Vout	--	200	--
	With a 1µF/100V X7R MLCC	48Vout, 53Vout	--	300	--
Temperature coefficient		-0.02	--	+0.02	%/°C
Transient response recovery time	25% load step change	--	250	--	µs
Over voltage protection	% of Vout(nom); Hiccup mode	115	--	130	
Overload protection	% of Iout rated; Hiccup mode	120	--	150	%
Short circuit protection		Continuous, automatic recovery			

General Specifications

Parameter	Conditions	Min	Typ	Max	Unit	
Isolation voltage	1 minute (Reinforced insulation)	Input to Output	3000	--	--	V AC
		Input (Output) to Base-Plate	1500	--	--	
Isolation resistance	500VDC	1	--	--	GΩ	
Isolation capacitance		--	1000	--	pF	
Switching frequency		189	210	231	kHz	
Safety approvals		IEC/ EN/ UL62368-1				
Standard approvals		EN50155 EN45545-2				
Case material		Aluminum base-plate with plastic case				
Potting material		Silicone (UL94 V-0)				
Weight		113g (3.99oz)				
MTBF	MIL-HDBK-217F, Full load	3.093 x 10 ⁵ hrs				

Environmental Specifications

Parameter	Conditions	Min	Typ	Max	Unit
Operating base-plate temperature	With derating	-40	--	+105	°C
Maximum case temperature		--	--	105	
Over temperature protection		--	115	--	
Storage temperature range		-55	--	+125	
Thermal impedance	Module without assembly option	--	6.1	--	°C/W
	Only mount on the aluminum base-plate	--	2.0	--	
	Heat-sink type with 0.65" Height	--	4.6	--	
	Heat-sink type with 1" Height	--	3.7	--	
Thermal shock					MIL-STD-810F
Shock					EN61373, MIL-STD-810F
Vibration					EN61373, MIL-STD-810F
Relative humidity					5% to 95% RH

EMC Specifications

Parameter	Conditions	Level
EMI	EN55032, EN50121-3-2 With external components	Class A, Class B
EMS	EN55024 and EN50121-3-2	
ESD	EN61000-4-2 Air ± 8kV and Contact ± 6kV	Perf. Criteria A
Radiated immunity	EN61000-4-3 20 V/m	Perf. Criteria A
Fast transient	EN61000-4-4 ± 2kV	Perf. Criteria A
	With external components	
Surge	EN61000-4-5 ± 2kV	Perf. Criteria A
	With external components	
Conducted immunity	EN61000-4-6 10 Vr.m.s	Perf. Criteria A
Power frequency magnetic field	EN61000-4-8 100A/m continuous; 1000A/m 1 second	Perf. Criteria A

Note:

Refer to "TYPICAL APPLICATION" for detailed information about UVLO.

CAUTION:

This power module is not internally fused. An input line fuse must always be used.

The BUS pin is designed for enhanced hold-up function. It is not recommended to apply in different applications.

CBUS must be connected. Please refer to "CBUS" section.

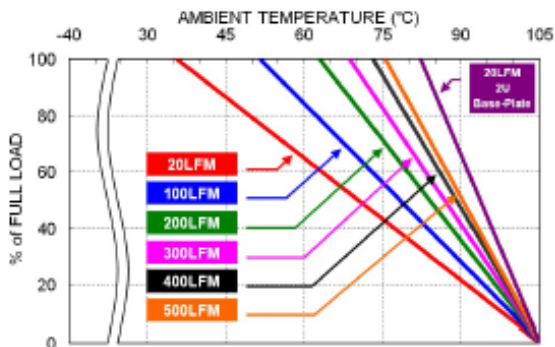
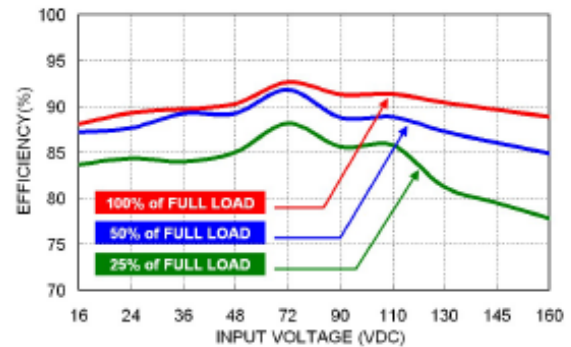
Characteristic Curve

 43HAE150-72S12UA Derating Curve
 (See Thermal Considerations)

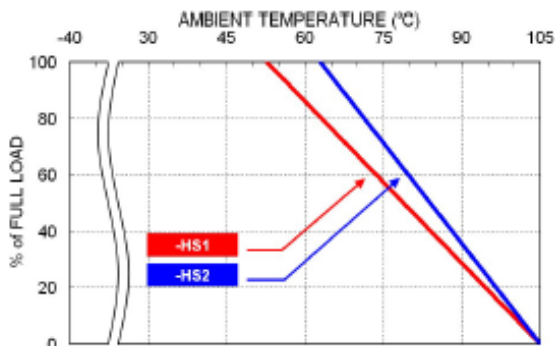
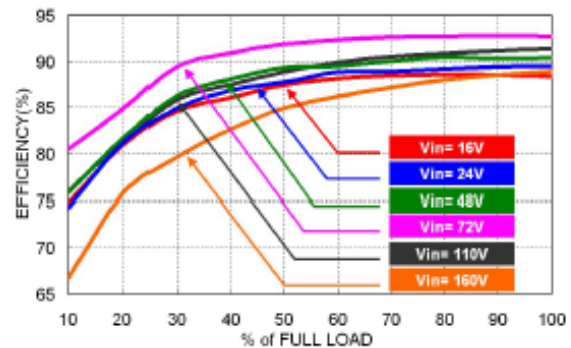
43HAE150-72S12UA Efficiency vs. Input Voltage

 43HAE150-72S12UA Derating Curve with Heat-sink
 (See Thermal Considerations)

43HAE150-72S12UA Efficiency vs. Output Load

Fuse Consideration

This power module is not internally fused. An input line fuse must always be used.

This encapsulated power module can be used in a wide variety of applications, ranging from simple stand-alone operation to an integrated part of sophisticated power architecture.

To maximum flexibility, internal fusing is not included; however, to achieve maximum safety and system protection, always use an input line fuse.

The input line fuse suggest as below :

Model	Fuse Rating (A)	Fuse Type
Input Line	15	Fast-Acting
BUS Line (option)	5	Fast-Acting

The table based on the information provided in this data sheet on inrush energy and maximum DC input current at low Vin.

Mechanical Drawing

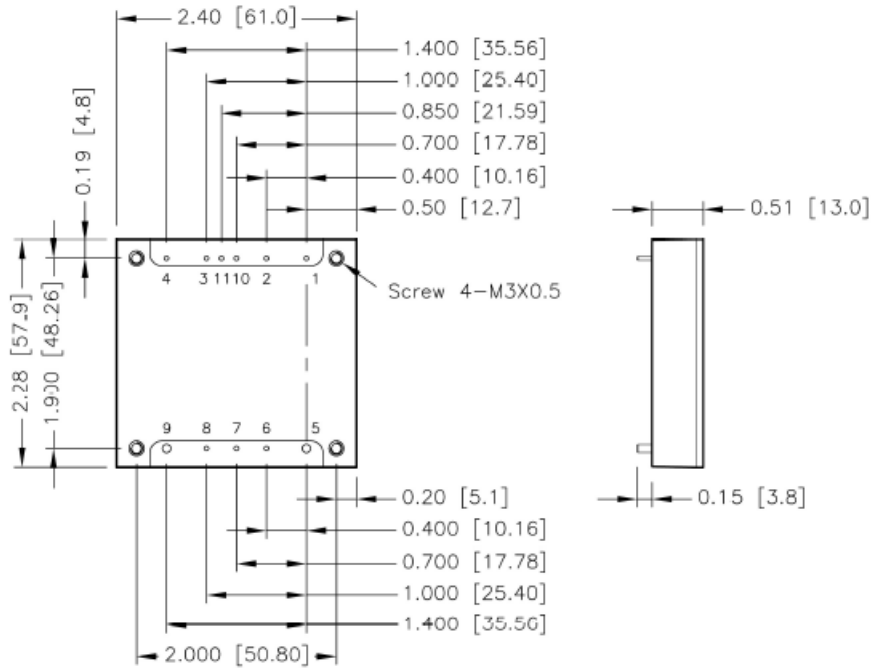

BOTTOM VIEW

■ The screw locked torque: MAX 3.5kgf-cm/0.34N-m

Pin Connection

Pin	A-Type	B-Type	Diameter
1	-Vin	-Vin	0.04 Inch
2	BUS	BUS	0.04 Inch
3	Ctrl	UVLO	0.04 Inch
4	+Vin	+Vin	0.04 Inch
5	-Vout	-Vout	0.08 Inch
6	-Sense	-Sense	0.04 Inch
7	Trim	Trim	0.04 Inch
8	+Sense	+Sense	0.04 Inch
9	+Vout	+Vout	0.08 Inch
10	UVLO	Ctrl	0.04 Inch
11	Pulse Out	Pulse Out	0.04 Inch

1. All dimensions in inch [mm]
2. Tolerance :x.xx±0.02 [x.x±0.5]
x.xxx±0.01 [x.xx±0.25]
3. Pin dimension tolerance ±0.004[0.10]

Recommended Pad Layout

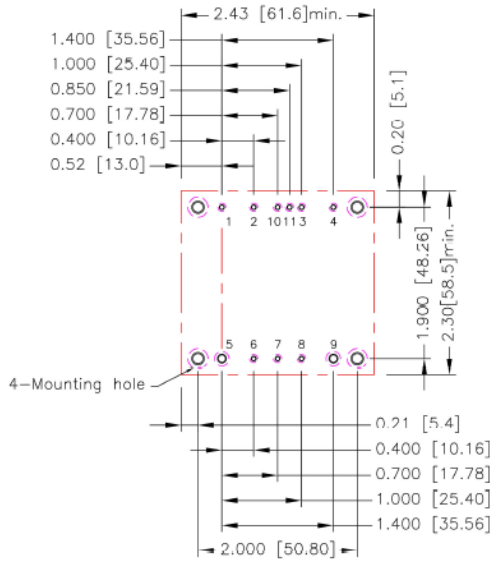

All dimensions in inch[mm]
 Pad size(lead free recommended)
 Through hole 1.2.3.4.6.7.8.10.11:Φ0.051[1.30]
 Through hole 5.9:Φ0.091[2.30]
 Through hole of mounting:Φ0.126[3.20]
 Top view pad 1.2.3.4.6.7.8.10.11:Φ0.064[1.63]
 Top view pad 5.9:Φ0.113[2.88]
 Top view pad of mounting:Φ0.157[4.00]
 Bottom view pad 1.2.3.4.6.7.8.10.11:Φ0.102[2.60]
 Bottom view pad 5.9:Φ0.181[4.60]
 Bottom view pad of mounting:Φ0.252[6.40]

Thermal Considerations

The power module operates in a variety of thermal environments. However, sufficient cooling should be provided to help ensure reliable operation of the unit. Heat is removed by conduction, convection, and radiation to the surrounding Environment. Proper cooling can be verified by measuring the point as the figure below. The temperature at this location should not exceed "Maximum case temperature". When operating, adequate cooling must be provided to maintain the test point temperature at or below "Maximum case temperature". You can limit this Temperature to a lower value for extremely high reliability.

- Thermal test condition with vertical direction by natural convection (20LFM).
- The aluminum base-plate dimension is 19" X 3.5" X 0.063" (The height is EIA standard 2U).
- The Heat-sink is optional and P/N: 7GA0127P01-F, 7GA0128P01-F.

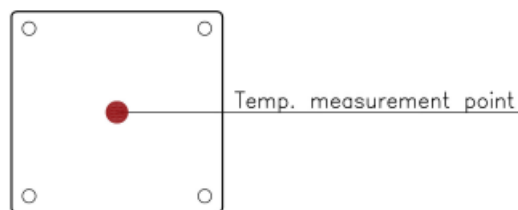

BASE PLATE

Heat-Sink Options

43HAE150-□□S□□UA/B -HS4
7GA0127P01-F

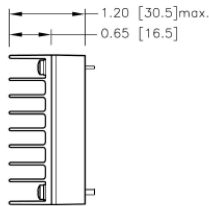
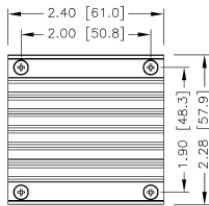

SIDE VIEW

43HAE150-□□S□□UA/B -HS5
7GA0128P01-F

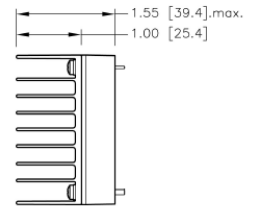
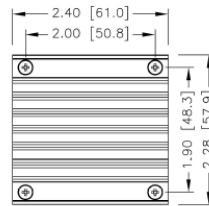

SIDE VIEW

1. All dimensions in inch [mm]
2. Tolerance: $x.xx \pm 0.02$ [$x.x \pm 0.5$]
 $x.xxx \pm 0.01$ [$x.xx \pm 0.25$]
3. Pin dimension tolerance ± 0.004 [0.10]

Typical Application

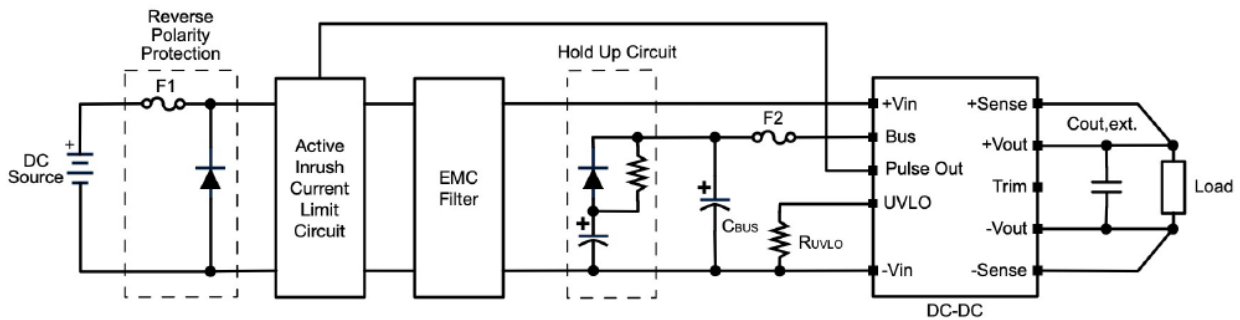

Typical Connection

CBUS

An 150µF Electrolytic Cap should always be installed and connected to the BUS pin for module's stability.

*F2 is not necessarily needed. The fuse, F2, can protect the dc/dc module from damage caused by short-circuiting of peripheral components connected to the BUS pin.

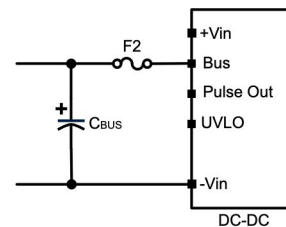

CBUS	150µF / 200V , Nippon Chemi-con KXJ series
F2	5A Fast-Acting , Little fuse

Typical Application (Continued)

UVLO

UVLO pin provides the function of programmable input turn on/ off voltage by connecting a resistor between UVLO and -Vin. The following equations are used for calculating the value of input voltage and RUVLO. Or can simply reference the table shown as below to obtain the suitable RUVLO value to the system.

$$V_{in, ON} = \frac{451.23}{R_{UVLO} + 3} + 13.26 \quad (V)$$

$$V_{in, OFF} = \frac{448.5}{R_{UVLO} + 3} + 11.00 \quad (V)$$

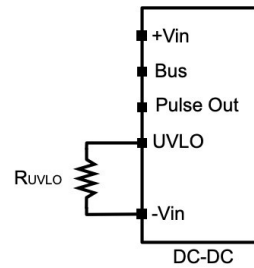

Reference table for RUVLO

System Voltage, Un (V)	24	36	48	72	96	110
Start-up Voltage (V)	13.3	21.6	28.8	43.2	57.6	66.0
Shutdown Voltage (V)	11.0	19.3	26.4	40.8	55.1	63.4
RUVLO (kΩ)	Open	51.12	26.04	12.07	7.18	5.56

Pulse Out

The Pulse out pin can provide 12V, 1kHz, 50% duty square wave signal. It provides the function that could achieve inrush current limit with external circuit. If Pulse Out pin is not to be used, please left this pin floating.

When Pulse Out pin is high level, the source current of pulse out pin should be limited no more than 10mA. For resistive load, higher than 1.2kΩ is necessary.

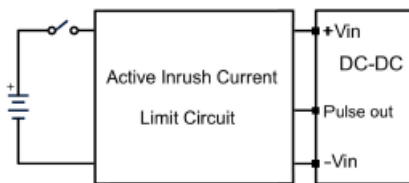

Pulse Out Connection

Reference table for RUVLO

System Voltage, Un (V)	24	36	48	72	96	110
Start-up Voltage (V)	13.3	21.6	28.8	43.2	57.6	66.0
Shutdown Voltage (V)	11.0	19.3	26.4	40.8	55.1	63.4
RUVLO (kΩ)	Open	51.12	26.04	12.07	7.18	5.56

Output Voltage Adjustment

Output voltage is adjustable for 10% trim up or -20% trim down of nominal output voltage by connecting an external resistor between the Trim pin and either the +Sense or -Sense pins. With an external resistor between the Trim and -Sense pin, the output voltage set point decreases. With an external resistor between the Trim and +Sense pin, the output voltage set point increases. Maximum output deviation is +10% inclusive of remote sense. The external TRIM resistor needs to be at least 1/8W of rated power.

Trim Up Equation

$$R_U = \left(\frac{V_{OUT}(100 + \Delta\%) - 100 + 2\Delta\%}{1.225\Delta\%} \right) k\Omega$$

Trim Down Equation

$$R_D = \left(\frac{100}{\Delta\%} - 2 \right) k\Omega$$

Trim Up
EXTERNAL OUTPUT TRIMMING

Output can be externally trimmed by using the method shown below.

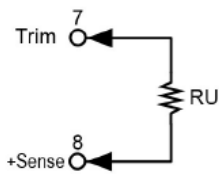
72S05UA/B

ΔV (%)	1	2	3	4	5	6	7	8	9	10
Vout (V)	5.05	5.10	5.15	5.20	5.25	5.30	5.35	5.40	5.45	5.50
RU (kΩ)	310.245	156.163	104.803	79.122	63.714	53.442	46.105	40.602	36.322	32.898

72S12UA/B

ΔV (%)	1	2	3	4	5	6	7	8	9	10
Vout (V)	12.12	12.24	12.36	12.48	12.60	12.72	12.84	12.96	13.08	13.20
RU (kΩ)	887.388	447.592	300.993	227.694	183.714	154.395	133.452	117.745	105.528	95.755

72S15UA/B

ΔV (%)	1	2	3	4	5	6	7	8	9	10
Vout (V)	15.15	15.30	15.45	15.60	15.75	15.90	16.05	16.20	16.35	16.50
RU (kΩ)	1134.735	572.490	385.075	291.367	235.143	197.660	170.886	150.806	135.188	122.694

72S24UA/B

ΔV (%)	1	2	3	4	5	6	7	8	9	10
Vout (V)	24.24	24.48	24.72	24.96	25.20	25.44	25.68	25.92	26.16	26.40
RU (kΩ)	1876.776	947.184	637.320	482.388	389.429	327.456	283.190	249.990	224.168	203.510

72S28UA/B

ΔV (%)	1	2	3	4	5	6	7	8	9	10
Vout (V)	28.28	28.56	28.84	29.12	29.40	29.68	29.96	30.24	30.52	30.80
RU (kΩ)	2206.571	1113.714	749.429	567.286	458.000	385.143	333.102	294.071	263.714	239.429

Ideal Power Limited

14 Larks Way, Tree Beech Enterprise Park, Gunn, Barnstaple, Devon, England, EX32 7NZ.

www.idealpower.co.uk | +44 (0) 845 260 3400

Trim Up (Continued)
72S48UA/B

ΔV (%)	1	2	3	4	5	6	7	8	9	10
Vout (V)	48.48	48.96	49.44	49.92	50.40	50.88	51.36	51.84	52.32	52.80
RU (k Ω)	3855.551	1946.367	1309.973	991.776	800.857	673.578	582.665	514.480	461.447	419.020

72S53UA/B

ΔV (%)	1	2	3	4	5	6	7	8	9	10
Vout (V)	53.53	54.06	54.59	55.12	55.65	56.18	56.71	57.24	57.77	58.30
RU (k Ω)	4267.769	2154.531	1450.109	1097.898	886.571	745.6871	645.055	569.582	510.880	463.918

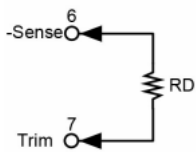
Trim Down

72S□□UA/B

ΔV (%)	1	2	3	4	5	6	7	8	9	10
RD (k Ω)	98.000	48.000	31.333	23.000	18.000	14.667	12.286	10.500	9.111	8.000

ΔV (%)	11	12	13	14	15	16	17	18	19	20
RD (k Ω)	7.091	6.333	5.692	5.143	4.667	4.250	3.882	3.556	3.263	3.000